

M12 Straight Female Metal Assembled Plug Screw



- European standard connector M12 series
- Structure type: Metal Ssembled Dstraight Plug
- Pin type: Female type
- Contacts number: 2,3,4,5,6,8 Pins
- Connection method: Screw
- Shield: Yes
- Certification: CE,RoHS,UL ,
- Standard: IEC 61076-2-101

Technical Parameter

Shell material	brass nickel plating/zinc alloy nickel/PA+GF
Insulator material	PA+GF/TPU
Sealing material	epoxy resin/rubber
Contact material	brass /phosphorus copper gold-plated
Molding material	TPU/PVC
Insulation impedance	$\geq 100 \text{ M } \Omega$
Contact impedance	$\leq 5 \text{ m } \Omega$
Durability	≥ 500 cycles
Applicable temperature	-25 °C~+80 °C
Waterproof	IP65/IP67
Executive standard	IEC 61076-2-101

M12 Straight Female Metal Assembled Plug Screw



DIMENSION

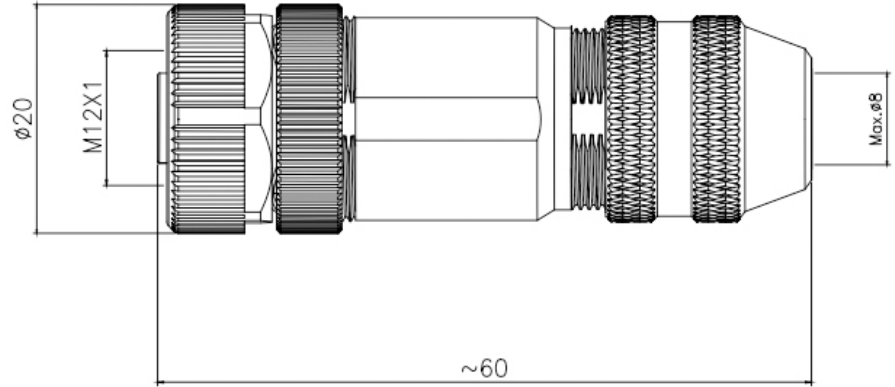

WIRING DEFINITION

芯位 Pins	线芯颜色 Wire core color
2芯(Pins)	
1	BN
2	-
3	BU

芯位 Pins	线芯颜色 Wire core color
3芯(Pins)	
1	BN
2	-
3	BU
4	BK

芯位 Pins	线芯颜色 Wire core color
6芯(Pins)	
1	BN
2	WH
3	BU
4	BK
5	-
6	GY
7	RD

芯位 Pins	线芯颜色 Wire core color
8芯(Pins)	
1	WH
2	BN
3	GN
4	YE
5	GY
6	PK
7	BU
8	RD

芯位 Pins	线芯颜色 Wire core color					
	4芯A编码(4 Pins A-Code)		4芯B编码(4 Pins B-Code)		4芯D编码(4 Pins D-Code)	
1	BN	BN	BN	BN	YE	YE
2	WH	WH	WH	WH	WH	WH
3	BU	BU	BU	BU	OG	OG
4	BK	BK	BK	BK	BU	BU

芯位 Pins	线芯颜色 Wire core color
12芯(Pins)	
1	BN
2	BU
3	WH
4	GN
5	PK
6	YE
7	BK
8	GY
9	RD
10	VT
11	OG
12	LTGN





























芯位 Pins	线芯颜色 Wire core color
17芯(Pins)	
1	BN
2	BU
3	WH
4	GN
5	PK
6	YE
7	BK
8	GY
9	RD
10	VT
11	OG
12	LTGN
13	LTBU
14	BKWH
15	BNWH
16	RDWH
17	BUWH

*接线定义按常规标准，如按协议或者其他请联系我司业务。

Wiring definition according to conventional standards, if according to the agreement or other please contact our sales.

ELECTRICAL PARAMETERS

M12 Straight Female Metal Assembled Plug Screw

芯数 Pins	针型 Male				额定电流 Rated current	额定电压 Rated voltage		导体规格 Conductor size		孔型 Female			
	A	B	C	D		A/C	D/C	AWG	mm ²	A	B	C	D
2					4A	250V	250V	22	0.34				
3					4A	250V	250V	22	0.34				
4					4A	250V	250V	22	0.34				
5					4A:A型(A-Code) B型(B-Code) 2A:C型(C-Code)	60V	60V	22	0.34				
6					2A	30V	30V	24	0.25				
8					2A	30V	30V	24	0.25				
12					1.5A	30V	30V	26	0.14				
17					1.5A	30V	30V	26	0.14	